

Article number: 20194V25V252SW

Description: E+G

T-angel clamps GN194-V25-V25-2-SW

Measures

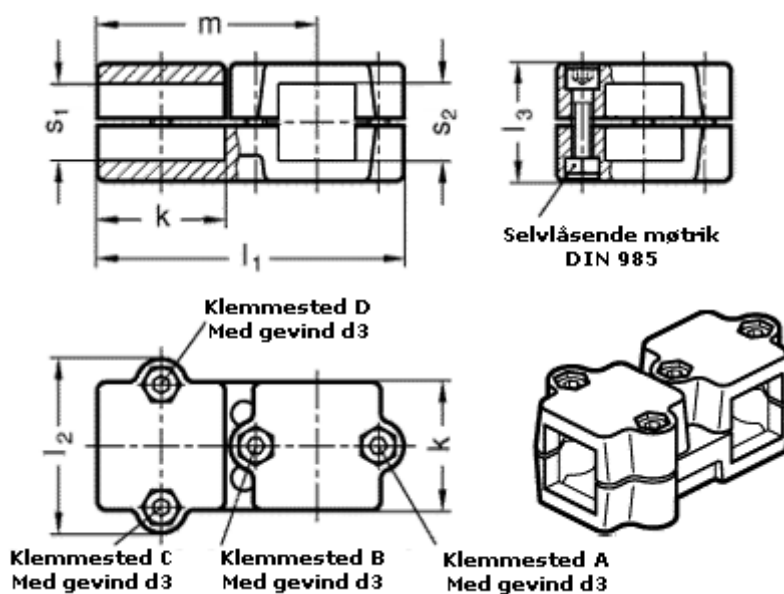

d3 = M 8

k = 50

l1 = 120

l2 = 68

l3 = 46

m = 85

s1 = 25

s2 = 25